

R&S® ENV216

Two Line V-Network

User Manual



5201669314
Version 06

ROHDE & SCHWARZ
Make ideas real



This document describes the following R&S®ENV216 models:

- R&S®ENV216 (3560.6550.11)
- R&S®ENV216 (3560.6550.12)
- R&S®ENV216 (3560.6550.13)
- R&S®ENV216 (3560.6550.14)
- R&S®ENV216 (3560.6550.15)
- R&S®ENV216 (3560.6550.16)

© 2023 Rohde & Schwarz GmbH & Co. KG
Muehldorfstr. 15, 81671 Muenchen, Germany
Phone: +49 89 41 29 - 0
Email: info@rohde-schwarz.com
Internet: www.rohde-schwarz.com

Subject to change – data without tolerance limits is not binding.

R&S® is a registered trademark of Rohde & Schwarz GmbH & Co. KG.

All other trademarks are the properties of their respective owners.

5201.6693.14 | Version 06 | R&S®ENV216

Throughout this manual, products from Rohde & Schwarz are indicated without the ® symbol, e.g. R&S®ENV216 is indicated as R&S ENV216.

Contents

1	Safety and regulatory information.....	5
1.1	Safety instructions.....	5
1.2	Labels on the product.....	9
1.3	Warning messages in the documentation.....	9
1.4	Korea certification class B.....	10
2	Preface.....	11
2.1	Introduction.....	11
2.2	Block diagram.....	12
2.3	Unpacking and checking.....	12
3	Instrument tour.....	13
3.1	Front panel tour.....	13
3.2	Rear panel tour.....	15
4	Preparing for use.....	17
4.1	Setting up the R&S ENV216.....	17
4.2	Connecting to protective ground.....	18
4.3	Connecting to power.....	18
4.4	Operating on non-standardized voltages.....	20
4.5	Connecting to reference ground.....	21
4.6	Connecting the equipment under test.....	21
4.7	Connecting the test receiver.....	22
4.8	Measurement setup.....	23
4.9	Sample measurement.....	24
5	Remote control.....	26
6	Maintenance, storage and disposal.....	28
6.1	Device safety inspection.....	28
6.2	Testing the PE grounding connection.....	28
6.3	Measuring the PE conductor's resistance.....	29
6.4	Contacting customer support.....	30
6.5	Storage and packaging.....	31

6.6 Disposal.....	31
Annex.....	32
A Country-specific connector models.....	32

1 Safety and regulatory information

The product documentation helps you use the product safely and efficiently. Follow the instructions provided here and in the following chapters.

Intended use

The R&S ENV216 Two Line V-Network is used to measure the unsymmetric disturbance voltage on AC mains and DC lines.

Its principal tasks are:

- To supply the equipment under test with mains voltage
- To provide a standardized load impedance
- Defined transmission of the noise voltage generated by the equipment under test to the EMI test receiver
- Isolation of the test circuit from interference of the power source.

The R&S ENV216 Two Line V-Network is constructed using air-core inductances and conforms with the requirements of CISPR 16-1-2 (EN 55016-1-2).

Target audience

Only connect, set up and use LISNs if you are an electrically skilled person. Electrically skilled persons have the relevant education and experience to enable them to perceive risks and to avoid hazards that electricity can cause. Follow the safety instructions provided in [Chapter 1.1, "Safety instructions"](#), on page 5 and the additional information provided during setup or operation procedures.

Where do I find safety information?

Safety information is part of the product documentation. It warns you of potential dangers and gives instructions on how to prevent personal injury or damage caused by dangerous situations. Safety information is provided as follows:

- In [Chapter 1.1, "Safety instructions"](#), on page 5. The same information is provided in many languages as printed "Safety Instructions". The printed "Safety Instructions" are delivered with the product.
- Throughout the documentation, safety instructions are provided when you need to take care during setup or operation.

1.1 Safety instructions

Products from the Rohde & Schwarz group of companies are manufactured according to the highest technical standards. To use the products safely, follow the instructions provided here and in the product documentation. Keep the product documentation nearby and offer it to other users.

Use the line impedance stabilization network (LISN) only for its intended use and within its performance limits. Intended use and limits are described in the product documenta-

tion such as the data sheet, manuals and the printed safety instructions. If you are unsure about the appropriate use, contact Rohde & Schwarz customer service.

LISNs are designed according to CISPR 16-1-2 (EN 55016-1-2) and do not meet the permissible limit for the leakage current as defined in EN 61010-1. In addition, LISNs do not provide basic insulation, rated as measurement category II (protection class 1). Therefore, only connect, set up and use LISNs if you are an electrically skilled person. Electrically skilled persons have the relevant education and experience to enable them to perceive risks and to avoid hazards that electricity can cause.

These users also need sound knowledge of at least one of the languages in which the user interfaces and the product documentation are available.

LISNs can pose hazardous and even life-threatening risks:

- Electrical shock because of a high leakage current and live parts if the LISN is not grounded.
- Electrical shock because the LISN does not have a fuse in the measuring circuit.
- Burns and fire hazard caused by overheating of the housing. Overheating can occur if the ventilation is insufficient or if the cables' cross-section is too small.

If any part of the LISN is damaged or broken, stop using the LISN. Never open the casing of the LISN. Only service personnel authorized by Rohde & Schwarz are allowed to repair the LISN. Contact Rohde & Schwarz customer service at <http://www.rohde-schwarz.com/support>.

Lifting and carrying the product

Look up the weight in the data sheet. If the product is heavy, you cannot move or carry it on your own. A single person can only carry a maximum of 18 kg safely, depending on age, gender and physical condition. To move the product safely, you can also use lifting or transporting equipment such as lift trucks or forklifts. Follow the instructions provided by the lifting or transporting equipment manufacturer.

Choosing the operating site

Only use the LISN indoors in rooms equipped with a protective earth connection (for example EMC test rooms). The product casing is not waterproof and water that enters the casing can electrically connect the casing with live parts. This can lead to electric shock, serious personal injury or death if you touch the casing.

You can operate the product up to an altitude of 2000 m above sea level. The product is suitable for pollution degree 2 environments where nonconductive contamination can occur.

For more information on environmental conditions such as ambient temperature and humidity, see the data sheet.

Setting up the product

Always place the LISN on a stable, flat and level surface with the bottom of the LISN facing down. Make sure that the air supply is not obstructed from any side.

Place the LISN on a nonflammable base, for example, a metal plate, to prevent a fire if the ventilation system fails or if it gets too hot.

If the LISN has foldable feet, always fold the feet completely in or out to ensure stability. The feet can collapse if they are not folded out completely or if the LISN is moved without lifting it. The foldable feet are designed to carry the weight of the LISN, but not an extra load.

Observe the applicable national regulations and standards as part of the installation process.

Protective ground connection

Always establish a protective ground connection before connecting the LISN to a power source. A protective ground protects you from electrically live parts on the casing caused by high leakage currents. High leakage currents can cause electric shock, serious personal injury or death if you touch the casing.

Take the following measures for your safety:

- Only use ground cables that have a sufficient cross-section that complies with VDE 0100-540 part 5-54 (IEC 60364-5-54).
- Screw one end of the ground cable to the protective grounding bolt on the product. Fix the other end of the ground cable securely to the grounding conductor of the measurement area.
- Validate that the ground connection is safe.
- The ground connection must remain until you have disconnected the LISN from the power source.

Connecting to power

The product is an overvoltage category II product and has to be connected to a fixed installation used to supply energy-consuming equipment such as household appliances and similar loads. Electrically powered products have risks, such as electric shock, fire, personal injury or even death.

Observe the protective measures given by VDE 0100-410 (IEC60364-4-41) while working with the LISN.

Take the following measures for your safety:

- Use double-insulated connecting cables with an appropriate minimum cross-section and an appropriate minimum voltage rating.
Select the cable based on the maximum power consumption of the device under test, the fuse rating of the building installation and the cable length. When installing the supplied cable sockets, observe the assembly instructions and the requirements of the manufacturer.
- By design, LISNs do not have a fuse in the measuring circuit. Therefore, you have to make sure that the operating circuit between the power supply and the power connector of the LISN is fused correctly.
- Only use the power cable delivered with the product. It complies with country-specific safety requirements.
- Only use intact cables and route them carefully so that they cannot be damaged. Check the power cables regularly to ensure that they are undamaged. Also ensure that nobody can trip over loose cables.

- Only connect the product to a power source with a maximum fuse protection according to the datasheet.
- Ensure that you can disconnect the product from the power source at any time. Pull the power plug to disconnect the product. The power plug must be easily accessible. If the product is integrated into a system that does not meet these requirements, provide an easily accessible circuit breaker at the system level.
- If the LISN has an auxiliary voltage: Before taking the LISN auxiliary voltage into operation, ensure that the voltage and frequency indicated on the product match the available power source. If the values do not match, contact Rohde & Schwarz customer service.
If the ventilation system is powered by an auxiliary voltage, always connect the auxiliary voltage before taking the LISN into operation. Operation without the ventilation system leads to overheating and can cause a fire.
- If the LISN can be powered by an external power supply, make sure that the power supply complies with the requirements for reinforced/double insulation in accordance with DIN/EN/IEC/UL/CSA 61010-1, DIN/EN/IEC/UL/CSA 60950-1 or DIN/EN/IEC/UL/CSA 62368-1.

Using accessories

Select accessories that are suitable for the product and the measurement task, especially if they are from 3rd party manufacturers.





Measurement accessories, such as current clamps or artificial hands must comply with the measurement category of your test setup.



Cleaning the product

Use a dry, lint-free cloth to clean the product. When cleaning, keep in mind that the casing is not waterproof. Do not use liquid cleaning agents.

Meaning of safety labels

Safety labels on the product warn against potential hazards.

	<p>Potential hazard</p> <p>Read the product documentation to avoid personal injury or product damage.</p>
	<p>Heavy product</p> <p>Be careful when lifting, moving or carrying the product. Carrying the product requires a sufficient number of persons or transport equipment.</p>
	<p>Electrical hazard</p> <p>Indicates live parts. Risk of electric shock, fire, personal injury or even death.</p>
	<p>Hot surface</p> <p>Do not touch. Risk of skin burns. Risk of fire.</p>
	<p>Protective conductor terminal</p> <p>Connect this terminal to a grounded external conductor or to protective ground. This connection protects you against electric shock if an electric problem occurs.</p>



	Warning: laser beam The product contains a laser.
	Avoid exposure to direct or reflected laser beam.

1.2 Labels on the product

Labels on the casing inform about:

- Personal safety, see ["Meaning of safety labels"](#) on page 8
- Product and environment safety, see [Table 1-1](#)

Table 1-1: Labels regarding product and environment safety

	Labeling in line with EN 50419 for disposal of electrical and electronic equipment after the product has come to the end of its service life.
	Grounding terminal (earth ground contact)
	Chassis grounding terminal

1.3 Warning messages in the documentation

A warning message points out a risk or danger that you need to be aware of. The signal word indicates the severity of the safety hazard and how likely it will occur if you do not follow the safety precautions.

DANGER

Imminently hazardous situation. Will result in death or serious injury if not avoided.

WARNING

Potentially hazardous situation. Could result in death or serious injury if not avoided.

CAUTION

Potentially hazardous situation. Could result in minor or moderate injury if not avoided.

NOTICE

Potential risks of damage. Could result in damage to the supported product or to other property.

1.4 Korea certification class B



이 기기는 가정용(B급) 전자파 적합기기로서 주로 가정에서 사용하는 것을 목적으로 하며, 모든 지역에서 사용할 수 있습니다.

2 Preface

2.1 Introduction

The R&S ENV216 Two Line V-Network is used to measure noise voltage on mains-dependent consumers.

Its principal tasks are:

- To supply the equipment under test with mains voltage
- To provide a standardized load impedance
- Defined transmission of the noise voltage generated by the equipment under test to the EMI test receiver
- Isolation of the test circuit from interference of the power source.

The R&S ENV216 Two Line V-Network is constructed using air-core inductances and conforms with the recommendations of CISPR 16-1-2 (EN 55016-1-2).

Other features of the equipment include:

- Artificial Hand
- 10-dB-attenuator in the RF path
- Switchable 150-kHz-highpass filter
- Switchable Pulse voltage limiter at the measurement output
- Remote control port
- External power supply via plug-in power supply for tests on non-standardized AC and DC voltages

The network may be operated manually or by remote control with TTL levels.

2.2 Block diagram

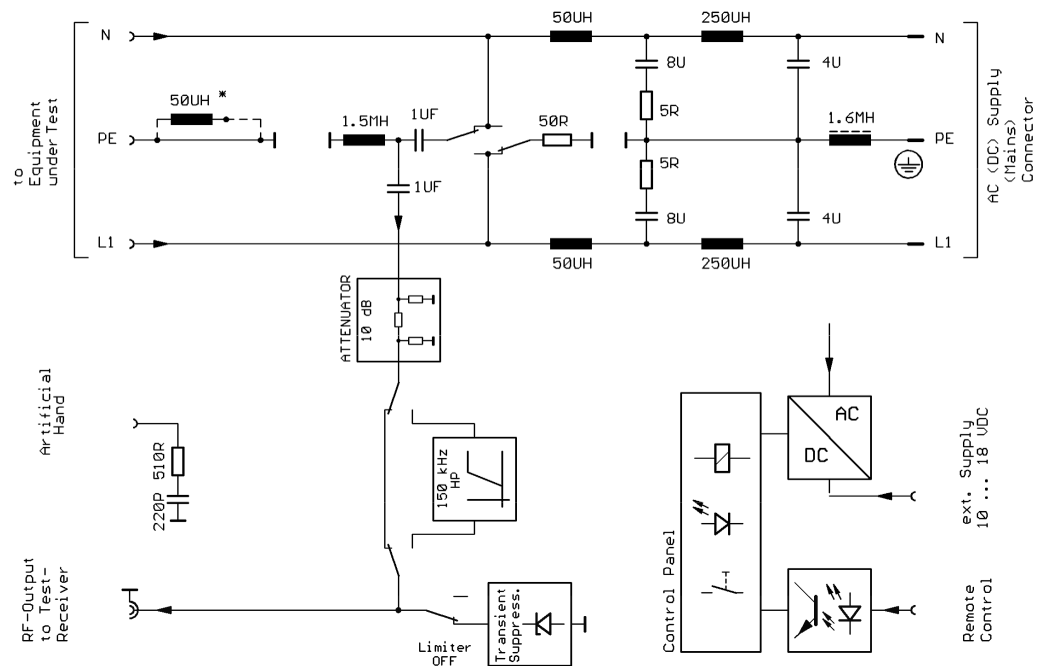

2.3 Unpacking and checking

Remove the two protective hoods from the front and rear and inspect the device carefully for any damage.

If the device is damaged, you should notify the responsible freight carrier immediately and retain all items of packaging in order to support your complaint. The original packaging is also useful for use when shipping or transporting at a later date. Keep at least the two protective hoods for the front and rear to protect the R&S ENV216 against damage to the control elements and connections.

3 Instrument tour

3.1 Front panel tour

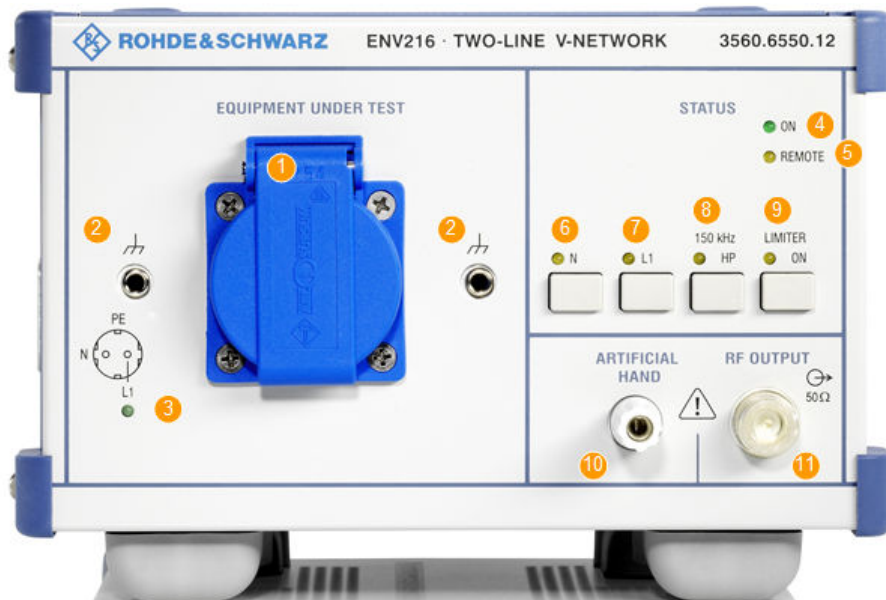

- 1 = EUT Socket
- 2 = Reference ground connectors (4-mm-jacks)
- 3 = L1 LED, phase indicator
- 4 = ON LED
- 5 = Remote LED
- 6 = N key
- 7 = L1 key
- 8 = 150 kHz highpass
- 9 = Limiter toggle
- 10 = Artificial hand connector
- 11 = RF output connector

EUT socket (1)

Socket for connecting the equipment under test.

For country-specific sockets, see [Chapter A, "Country-specific connector models"](#), on page 32.

Reference ground (2)

4-mm-jacks for connecting to the equipment under test. See also [Chapter 4.6, "Connecting the equipment under test"](#), on page 21.

L1 phase indicator (3)

Indicator showing the correct assignment of L1 and N to the measurement channels. LED "L1" lights up if the polarity of the mains plug is correct. See also [Chapter 4.3, "Connecting to power"](#), on page 18.

ON LED (4)

This LED shows that the R&S ENV216 is powered up.

Remote LED (5)

This LED shows that a remote control function is active. See also [Chapter 5, "Remote control"](#), on page 26.

This LED goes off automatically when all remote control functions are inactive or the port is not occupied.

L1, N (6), (7)

The measurement path is selected manually using the "L1" and "N" keys. When either key is pressed, it releases the other. They are both locked when the "Remote" LED is lit. The associated LEDs always indicate the active path, even when this has been selected using the remote control. See also [Chapter 5, "Remote control"](#), on page 26.

150 kHz HP (8)

With this toggle key, a 150 kHz highpass filter can be switched into the measurement path. This enables interference voltages in the low-frequency range, e.g. from switch-mode power supplies, to be suppressed. The associated LED lights up when the filter is active. This key is locked when the "Remote" LED is lit. See also [Chapter 5, "Remote control"](#), on page 26

 Limiter (9)

With this toggle key "Limiter" the internal protection diodes at the measurement output "RF Output" can be turned off. The protection diodes act as an input voltage limiter (transient limiter) attached before the "RF Output" output to protect measurement equipment from high positive and negative voltage spikes (>6 V). By turning off the protection diodes higher interference voltages can be measured.

The "Limiter ON" LED lights up when the protection diodes are active.

The default setting, e.g. after switching on, is "ON".

The limiter function is only locally switchable by the toggle key "Limiter".

CAUTION! When the protection diodes are turned off, ensure that the connected measurement devices cannot be damaged by high voltage spikes.

Artificial hand connector (10)

The "Artificial Hand" enables the effects of the human hand to be simulated. Metal housing parts of the equipment under test that are usually touched with the hand can be connected to this jack. The hand simulation consists of connection in series of a 510- Ω -resistor and a 220-pF-capacitor. The jack is a 4-mm-terminal clamp. See also [Chapter 4.9, "Sample measurement"](#), on page 24 for more information.

RF output connector (11)

The "RF Output" socket is the RFI voltage measurement output for connecting the test receiver. The RFI voltage spectrum of the selected path is attenuated at the "RF Output" by 10 dB. The 10-dB-attenuator and a transient suppressor are permanently inserted. A 150-kHz-highpass filter can also be switched into the path either manually or by remote control. The socket is an "N" type.

The output impedance is 50 Ω .

3.2 Rear panel tour



- 1 = Remote control connector
- 2 = Protective grounding bolt
- 3 = Mains connection cable
- 4 = Reference ground rail
- 5 = External power supply socket

Remote control connector (1)

Remote control port. This connection is used to enable remote control of measurement path "L1" or "N" and the "150 kHz HP" integral filter. See also [Chapter 5, "Remote control"](#), on page 26.

Protective ground connection (2)

The connection, a 6-mm-threaded bolt with nut is used only for protective grounding. It is not suitable for use as a reference ground.

Mains connection cable (3)

The mains connection cable is primarily used to supply power to the equipment under test.

When voltages under about 90 VAC are connected, and for all DC voltages, the auxiliary voltage for the ENV control circuit must be supplied externally by the plug-in power supply included with the device.

Reference ground rail (4)

The ground rail that is included on the side of the device is used exclusively for connecting a reference ground. A broad metal foil can be placed over it to create a low-inductance connection with the test setup.

External power supply socket (5)

Connection for the plug-in power supply. The control circuitry of the R&S ENV216 is powered via the "External Power Supply" socket, if the R&S ENV216 is to be used to conduct measurements of AC voltages below 90 VAC or on DC voltages up to 50 VDC. See also [Chapter 4.4, "Operating on non-standardized voltages"](#), on page 20.

4 Preparing for use

Before the R&S ENV216 is set up for operation, read the [Safety Instructions](#) carefully.

4.1 Setting up the R&S ENV216

Putting the R&S ENV216 into operation

Execute the following steps in the order as described. Additional important information is provided in separate chapters that are linked within each step.

1. Place the R&S ENV216 on a non-flammable surface (e.g. metal plate, marble slab).
2. Remove all surrounding items that could obstruct the ventilation openings of the R&S ENV216.
3. Establish an auxiliary [protective ground connection](#) of the R&S ENV216 that is independent from the mains supply.
4. Check if the voltage of the mains supply corresponds to the [specified operation range](#) of the R&S ENV216. Otherwise an external power supply can be necessary.
5. **DANGER!** Risk of electric shock. Before you connect the V-network to the power source, you have to connect the R&S ENV216 to a protective ground terminal. An unearthed R&S ENV216 is live. Touching a live electrical device causes serious personal injury, or even death.
The protective ground connection must remain until you have disconnected the V-network from the power supply.
Connect the R&S ENV216 to the [mains supply](#).
6. Connect the [equipment under test](#) to the R&S ENV216.
7. Connect the [test receiver](#) to the R&S ENV216.
Establish a reference ground connection for RF noise voltage measurement.
8. [Run the measurement](#).

Taking the R&S ENV216 out of operation

Execute the following steps in the order as described:

1. **DANGER!** Risk of electric shock. Always disconnect the R&S ENV216 from the power source before disconnecting it from anything else, especially the protective ground. An unearthed R&S ENV216 is live. Touching a live electrical device causes serious personal injury, or even death.
The protective ground connection must remain until you have disconnected the V-network from the power supply.
Disconnect the R&S ENV216 from the mains supply.

2. Disconnect the auxiliary protective ground connection of the R&S ENV216.

4.2 Connecting to protective ground

Before the R&S ENV216 is put into operation, the network must be connected to an additional conductor that is compliant with VDE0100.

Users must be aware that it is possible for socket connections and grounding conductors to become disconnected. A further grounding conductor with adequate diameter must be connected between a grounding conductor connection for the measurement area and the grounding bolt (1) on the R&S ENV216.

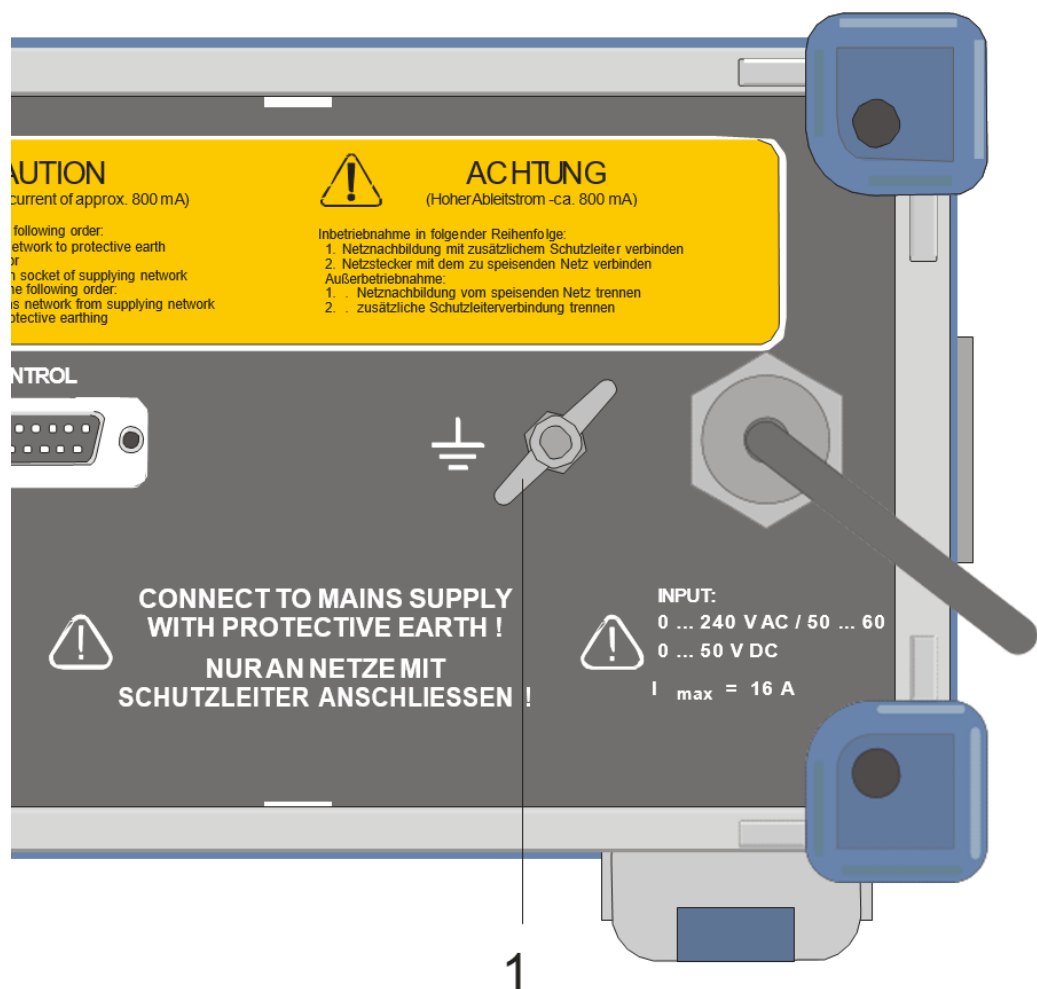

4.3 Connecting to power

Connection to the mains power supply is provided by a permanently attached mains cable.

The device is not equipped with an ON / OFF switch. Instead, the device plug of the connecting cable serves for disconnection from the AC supply (see ["Connecting to power"](#) on page 7).

1. **DANGER!** Risk of electric shock. Before you connect the V-network to the power source, you have to connect the R&S ENV216 to a protective ground terminal. An unearthed R&S ENV216 is live. Touching a live electrical device causes serious personal injury, or even death.

The protective ground connection must remain until you have disconnected the V-network from the power supply.

Connect the R&S ENV216 to the mains power supply.

2. If the phase connection is made correctly, LED L1 (1) must light up.

If it does not:

- For mains plugs with symmetrical grounding connection (e.g. Schuko plugs) the plug's polarity must be reversed.
- For mains plugs with asymmetrical grounding connection, phase L1 and neutral N must be swapped by reconnecting.
- For country-specific sockets, see [Chapter A, "Country-specific connector models"](#), on page 32.

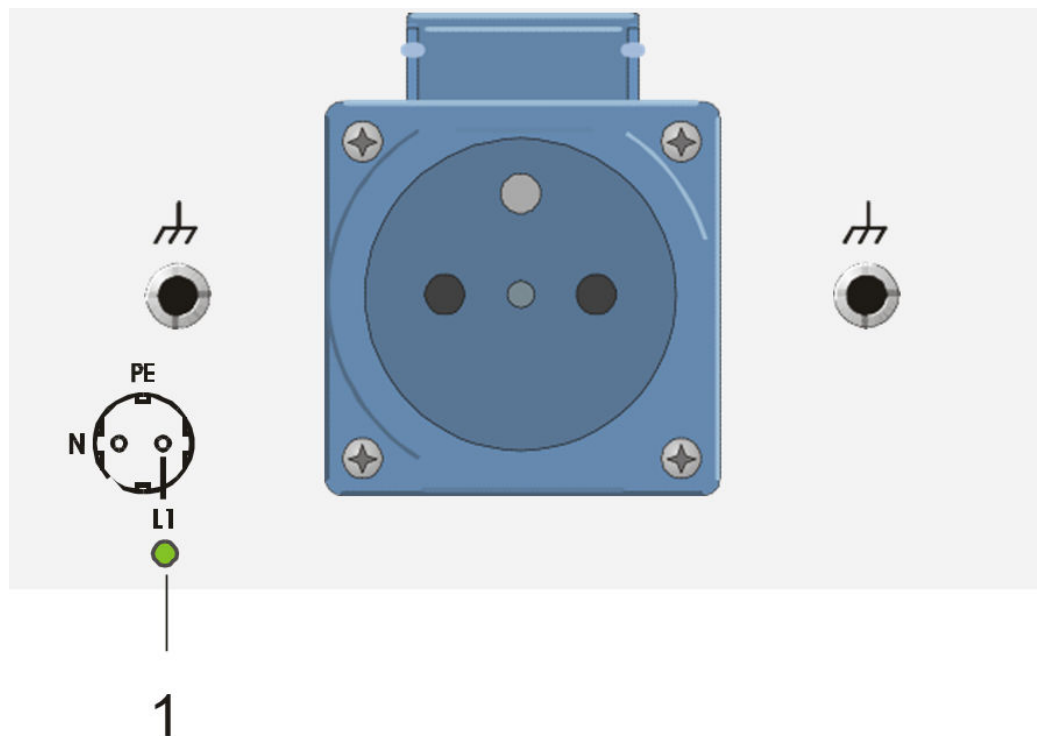

The plug on the mains cable can be adapted using a country-specific adapter.

However, it must be ensured that the adapter has a power rating of at least 16 A.

Assembly must be carried out exclusively by qualified technicians.

4.4 Operating on non-standardized voltages

For measurement tasks on voltages that are outside the normal mains voltage ranges (e.g. <90 VAC) and operation on DC (max. 50 VDC) the R&S ENV216 control circuit is powered by an external power supply.

1. Make sure that the DC voltage does not exceed 50 VDC. Higher DC voltages may damage the equipment.
2. **DANGER!** Risk of electric shock. Make sure that the external power supply complies with the requirements for reinforced/double insulation in accordance with DIN/EN/IEC/UL/CSA 61010-1, DIN/EN/IEC/UL/CSA 60950-1 or DIN/EN/IEC/UL/CSA 62368-1. An external power supply without reinforced/double insulation is live in case of failure. Touching a live electrical device causes serious personal injury, or even death.

Connect the external power supply to the "EXT. POWER SUPPLY" socket (1). The input is reverse voltage protected.

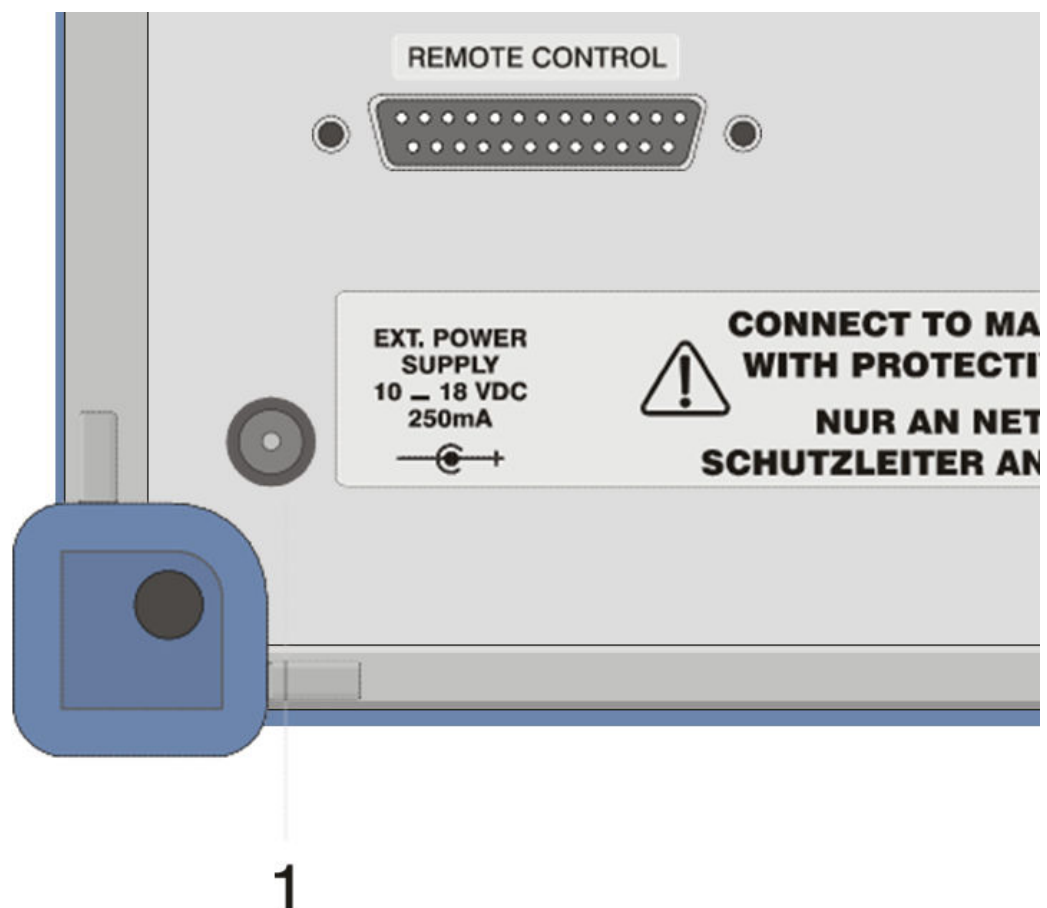

4.5 Connecting to reference ground

The network is connected to the PE grounding connection for the mains power supply through the mains cable, but this is not adequate for use as a reference ground in HF noise voltage measurement.

The reference ground used can be attached flat to the grounding rail (2) on the side of the device by a broad sheet metal with three metric M4 screws (1).



- 1 = Metric M4 screw
- 2 = Grounding rail

In order to prevent RF interference emitted by the mains grounding conductor from reaching the reference mass, the grounding conductor and the reference mass are decoupled by a PE-choke. This choke should not be bridged by the EMI test receiver, which is also connected to the measurement reference ground. Therefore, either an isolated or a battery-powered receiver must be used, or a PE choke must also be placed on the PE connection of the receiver.

4.6 Connecting the equipment under test

The equipment under test is connected via the socket (1) on the front of the R&S ENV216. Constant current must not exceed 16 A. For ambient temperatures >35°C, external air ventilation is recommended.

The RFI voltage measurement plane is located on the front panel of the R&S ENV216. The impedance gradient of connections N and L1 of the socket is measured against the reference ground connectors (4-mm-jacks) to the left and right (2) of the socket (1).

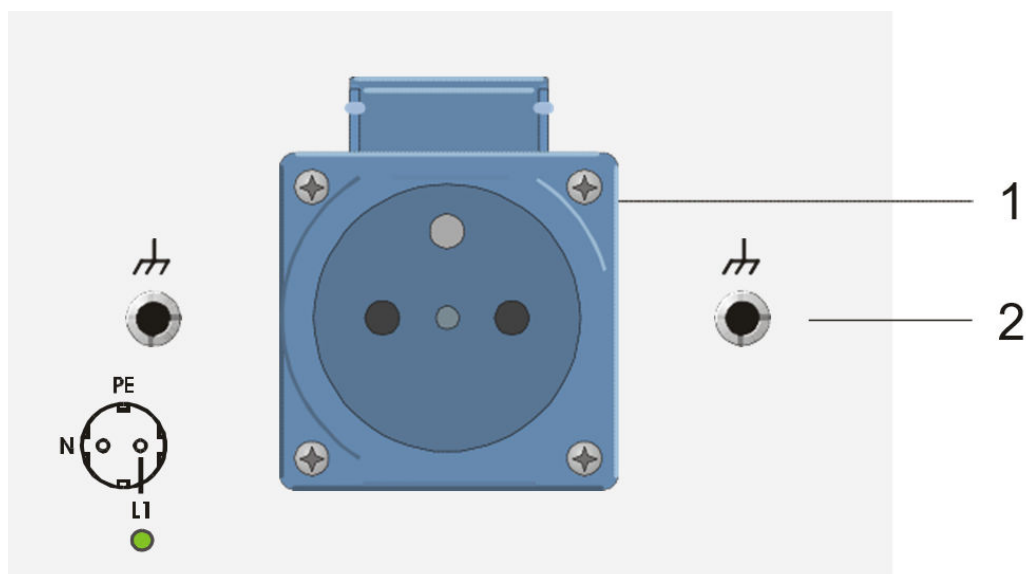

4.7 Connecting the test receiver

The test receiver is connected to the N connector RF OUTPUT (1) by a 50-Ω-coaxial cable.

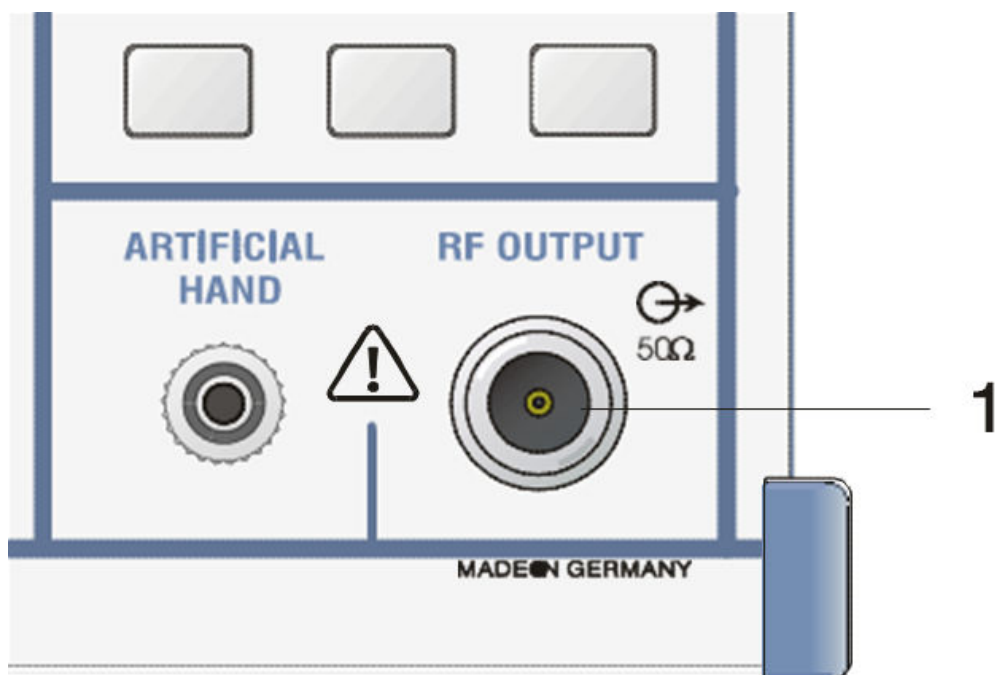

4.8 Measurement setup

The R&S ENV216 Two Line V-Network is suitable for measurements against CISPR, EN, VDE, ANSI, FCC Part 15 and MIL-STD-461 standards.

The measurement setups prescribed in the individual standards are largely similar. A detailed description is provided for example by the standard CISPR 14-1 and EN 55014-1, see also the following figure.

Devices under test that are not equipped with permanently attached connecting wires are connected to the network using a 1 meter long, unshielded wire. For devices under test equipped with a permanently attached cable that is longer than 1 meter, the cable is laid out in a folded configuration.

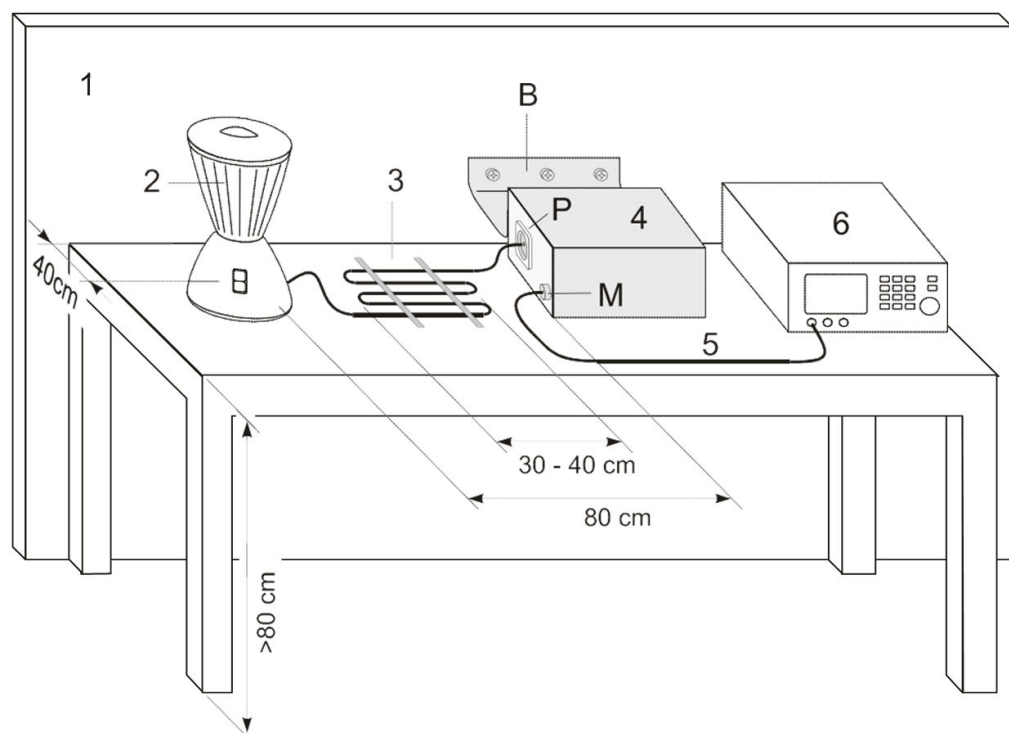

- 1 = Metal wall, at least 2 m x 2 m
- 2 = Equipment under test
- 3 = Cable in folded configuration
- 4 = Two-Line V-Network
- 5 = Shielded connection cable
- 6 = Test receiver
- B = Reference ground connection
- M = Test receiver connector
- P = Test device connector

Devices under test that have a separate ground connection and are not connected by integral grounding conductors are grounded using an additional connection cable. This is inserted into the ground connector (1) to the right of the test device socket and runs parallel to the mains cable.

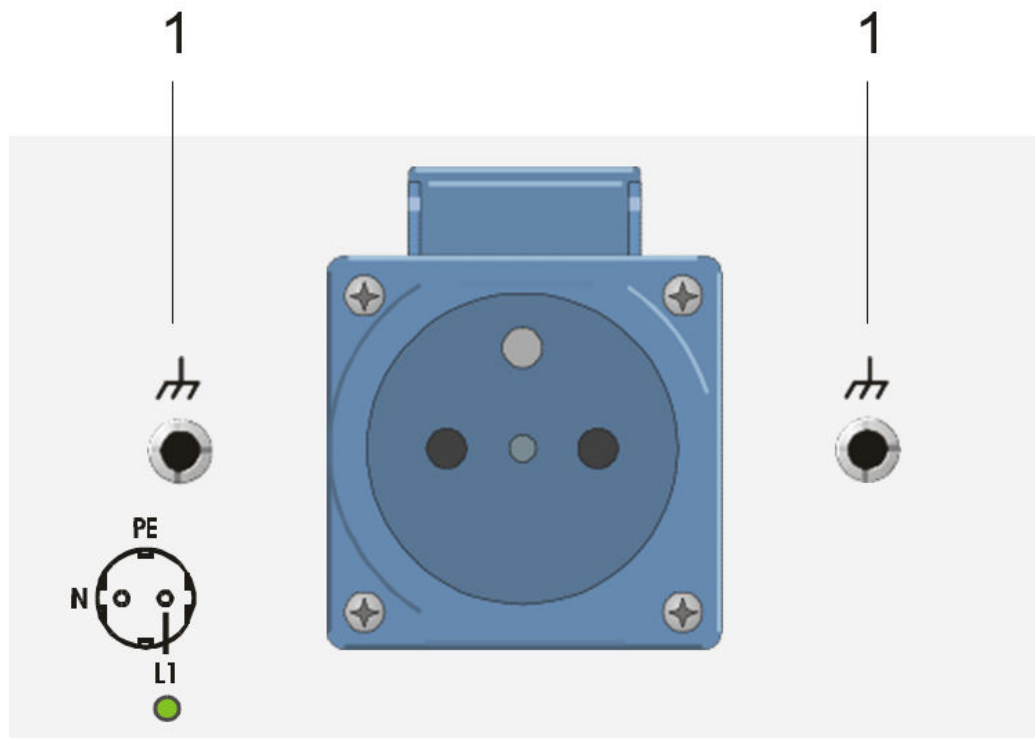

When measuring devices that are held in the hand during operation (e.g. electric drills), the effect of the human hand is simulated by connecting to the "Artificial Hand" hand simulation jack.

The hand simulation consists of the connection in series of a 220-pF-capacitor with a 510-Ω-resistor. The connection is located in the front panel of the R&S ENV216.

If the housing of the equipment under test is made entirely of metal, the "Artificial Hand" jack is connected to the housing the equipment under test.

If the housing is made from non-conductive material, metal foils are wound round the handles and a 60 mm wide foil is wound round the point on the housing that can also be gripped by the hand. All foils are connected together and with the "Artificial Hand" jack.

The figure in chapter 3, section entitled "Sample measurement" on the following page illustrates an example of how the foils are applied.

HF disturbers on the supply line of the R&S ENV216 may lead to interference voltages at the measurement output "RF Output".

4.9 Sample measurement

The figure shows the measurement setup for measuring the RFI voltage of a handheld drill. In this example, the handheld drill is connected to three metal foils.

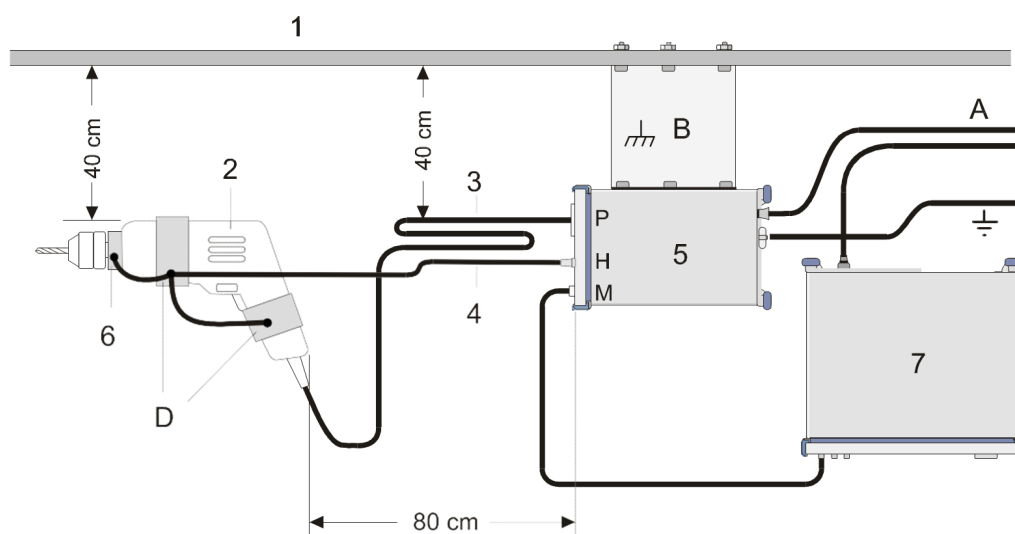

- 1 = Metal wall, at least 2 m x 2 m
- 2 = Equipment under test
- 3 = Connection cable
- 4 = Connection cable running separately to the hand simulation
- 5 = Two-Line V-Network
- 6 = Metallic collar capable being gripped
- 7 = Test receiver
- A = Power supply connection
- B = Reference ground connection, low-inductance (e.g. brass plate, 0.2 m)
- D = Metal foils
- H = Artificial Hand connector
- M = Test receiver connector
- P = Test device connector

5 Remote control

The functions L1, N and 150 kHz HP can be controlled remotely by applying a static LOW level to the appropriate contact of the SUB-D25 female connector (1) on the rear of the R&S ENV216.

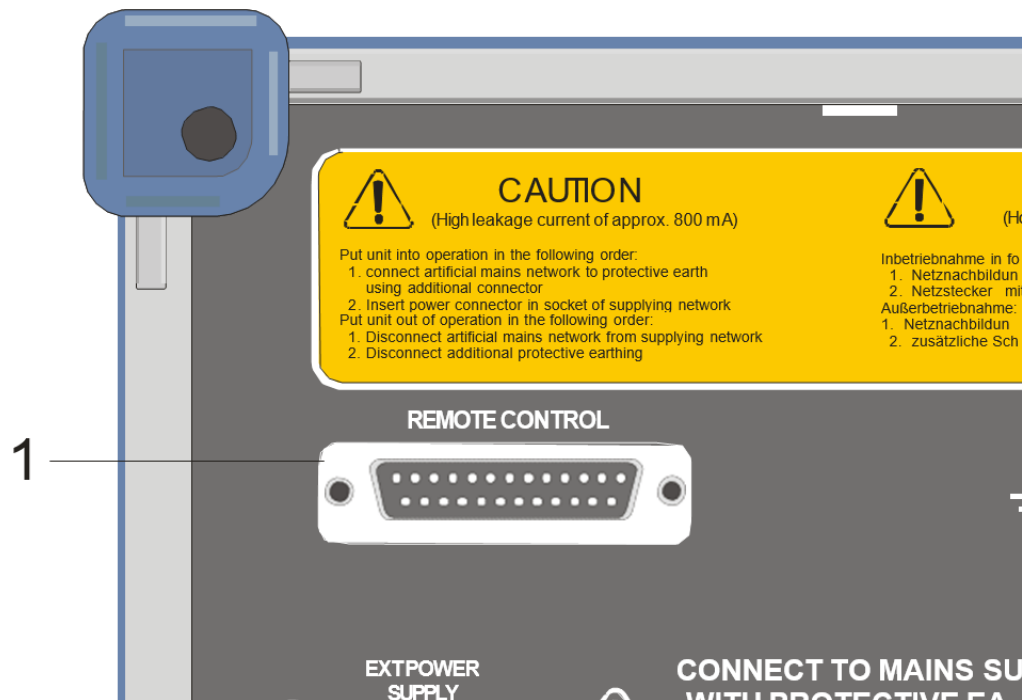

When a LOW signal is detected at input L1, N or 150 kHz HP, the corresponding function is activated and manual operation is blocked at the same time. The functions that have been switched on are indicated by the associated LEDs. When remote control is active, the REMOTE LED is lit.

When the LOW signal is removed, manual operation is enabled again and the status set manually prior to the remote operation is restored.

The settings are not saved if the device is disconnected from mains supply; instead, the default status (L1 "ON" and 150 kHz HP "OFF") is always restored when mains power is switched on.

The R&S ENV216 is configured for direct connection to Rohde & Schwarz test receivers.

If remote control is performed via an R&S receiver, the REMOTE LED is lit when the "ENV216" type network is selected. The user can choose between Phase "N" and "L1". The 150-kHz-highpass filter can be inserted into the signal path by pressing the "On" softkey in the LISN Settings dialog on the receiver.

The pulse limiter is not remote controllable. For safety reasons at remote control the pulse limiter is turned on. If it is assumed, that the pulse limiting influences the noise spectrum, it can be manually remeasured.

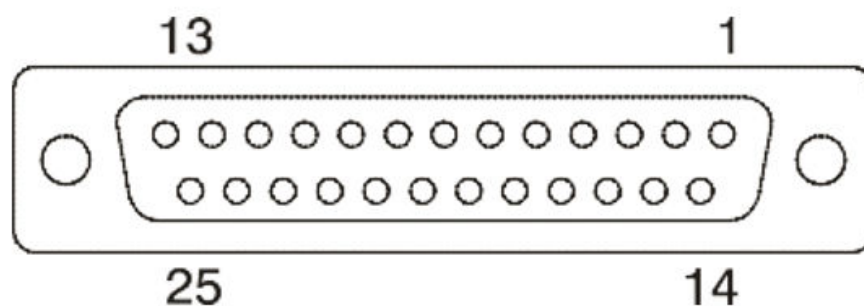
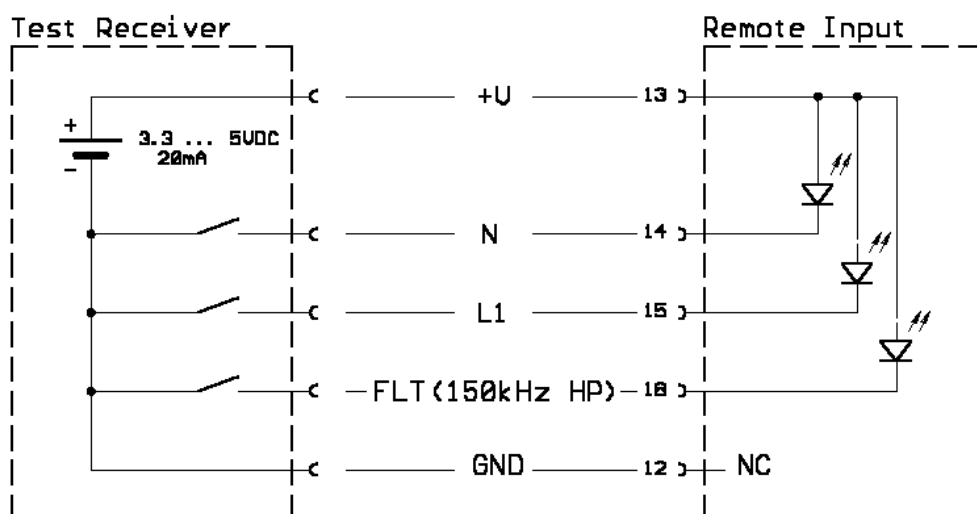

SUB-D 25 female

- 12 = GND
- 13 = TTL (+5V)
- 14 = N
- 15 = L1
- 18 = FLT

6 Maintenance, storage and disposal

Before any maintenance work on the R&S ENV216 is executed, read the [Safety Instructions](#) carefully.

The device does not need to be regularly maintained. Maintenance is limited essentially to wiping the device's external surfaces. See "[Cleaning the product](#)" on page 8.

6.1 Device safety inspection

A device safety inspection of the network as defined in BGV A3 is not possible because of the design according to CISPR 16-1-2 (EN 55016-1-2) and measurement set-up according to CISPR 16-2-1 (EN 55016-2-1). Therefore, the following examinations must be carried out as a minimum requirement.

6.1.1 Visual inspection

Ensure that parts relevant for active and passive safety are not visibly damaged or even unsuitable for use in the device.

1. Remove the R&S ENV216 from the mains supply.
2. Let the R&S ENV216 cool down to ambient temperature.
3. Check the following parts for damage:
 - a) Housing, displays, carrying handles, air vents
 - b) Device connection cables, connection points and mains lead cleats
 - c) Mains plug, fuse holder
 - d) Labeling and markings, warning notices
 - e) Isolated parts, wiring insulation
 - f) Plug connections and clamping points
 - g) Vent and leakage paths must not be altered unacceptably.

If any damage is detected, remove the R&S ENV216 from the test environment and contact R&S customer support. See [Chapter 6.4, "Contacting customer support"](#), on page 30.

6.2 Testing the PE grounding connection

This test is intended to determine whether the resistance between contactable parts, which must be securely grounded for safety reasons, and the grounding contact of the mains connector is less than 0.3 Ω .

During the measurement, the entire length of the wire is to be moved in sections. If a change in resistance is noted while part of the wire is being moved, the fault must be

found with a detailed troubleshooting procedure. Defective cables must not be repaired. They must be replaced in all cases.

6.3 Measuring the PE conductor's resistance

The resistance of the PE connection must be checked by a measurement according to Figure 6-1.

The test current is set to 10 A_{DC}.

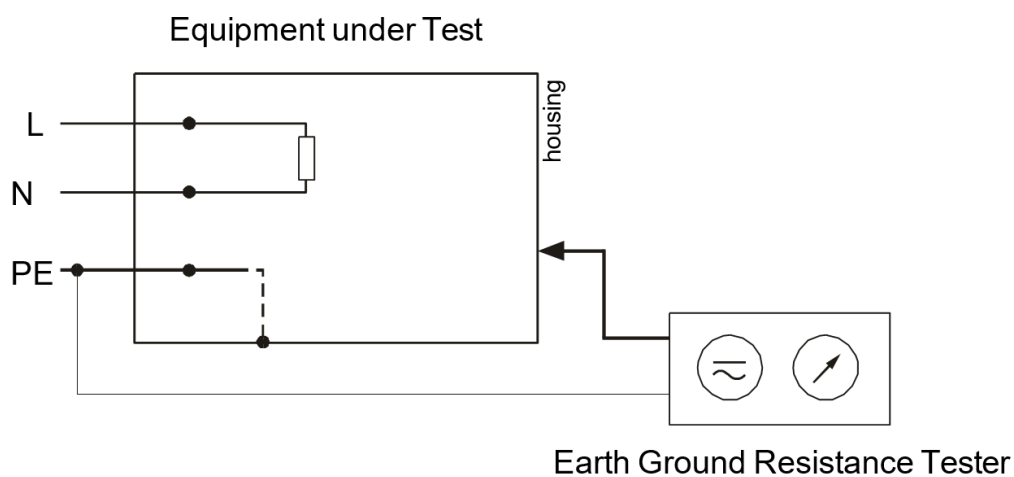
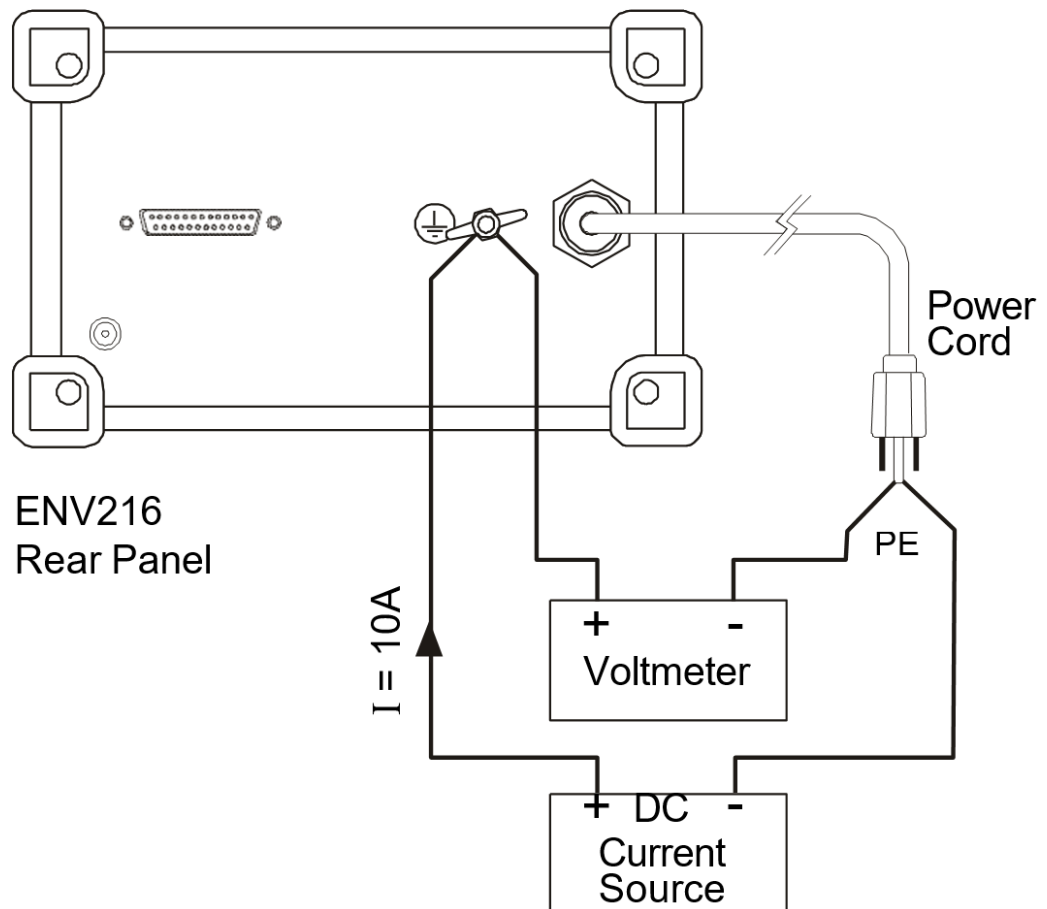

Figure 6-1: Measuring the resistance of the PE connection with device disconnected from the mains.

In addition to the usual points, measurements should also be taken from the PE contact of the mains plug to the bolt on the rear panel of the R&S ENV216.



The resistance of the PE connection is calculated from the voltage reading divided by the supplied current.

6.4 Contacting customer support

Technical support – where and when you need it

For quick, expert help with any Rohde & Schwarz product, contact our customer support center. A team of highly qualified engineers provides support and works with you to find a solution to your query on any aspect of the operation, programming or applications of Rohde & Schwarz products.

Contact information

Contact our customer support center at www.rohde-schwarz.com/support, or follow this QR code:



Figure 6-2: QR code to the Rohde & Schwarz support page

6.5 Storage and packaging

Protect the product against dust. Ensure that the environmental conditions, e.g. temperature range and climatic load, meet the values specified in the data sheet.

6.6 Disposal

Rohde & Schwarz is committed to making careful, ecologically sound use of natural resources and minimizing the environmental footprint of our products. Help us by disposing of waste in a way that causes minimum environmental impact.

Disposing electrical and electronic equipment

A product that is labeled as follows cannot be disposed of in normal household waste after it has come to the end of its service life. Even disposal via the municipal collection points for waste electrical and electronic equipment is not permitted.

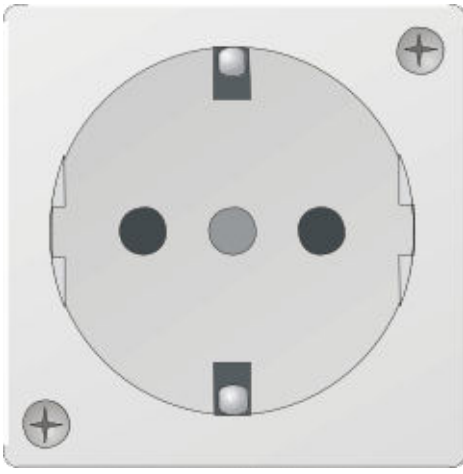
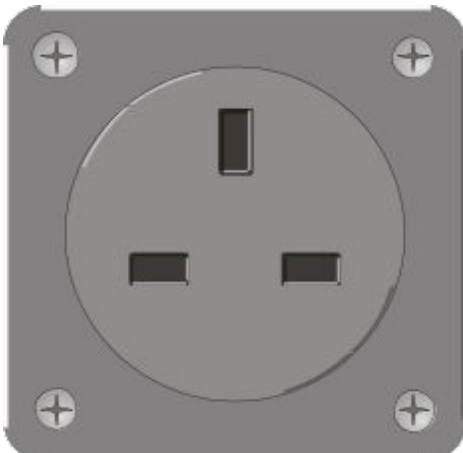
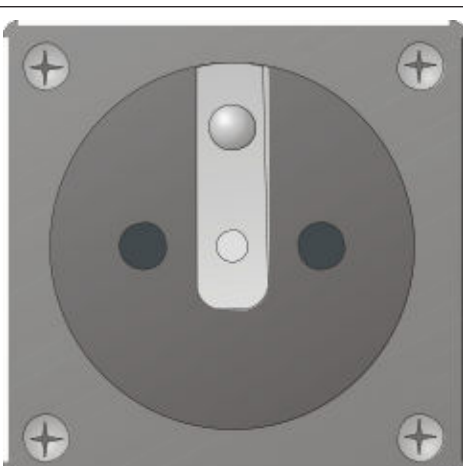



Figure 6-3: Labeling in line with EU directive WEEE

Rohde & Schwarz has developed a disposal concept for the eco-friendly disposal or recycling of waste material. As a manufacturer, Rohde & Schwarz completely fulfills its obligation to take back and dispose of electrical and electronic waste. Contact your local service representative to dispose of the product.

Annex

A Country-specific connector models

 A light grey square wall outlet with a circular opening. Inside the circle, there are two dark circular holes on the left and right, and a central grey circular hole. At the top and bottom of the circle, there are two small rectangular slots, each containing a white ball. The square has four screws, one in each corner.	<p>Germany as well as Australia, Finland, the Netherlands, Norway, Russia, Sweden; Occasionally: Portugal, Spain</p> <p>R&S ENV216 3560.6550.12</p>
 A dark grey square wall outlet with a circular opening. Inside the circle, there is a vertical rectangular slot at the top, and two horizontal rectangular slots on the left and right. The square has four screws, one in each corner.	<p>UK as well as Ireland, Hong Kong, Malaysia, Singapore</p> <p>R&S ENV216 3560.6550.13</p>
 A dark grey square wall outlet with a circular opening. Inside the circle, there is a vertical rectangular slot at the top containing a white ball. Below it are two dark circular holes on the left and right, and a central white circular hole. The square has four screws, one in each corner.	<p>France as well as Belgium and Czech Republic</p> <p>R&S ENV216 3560.6550.14</p>

 A circular, dark grey connector with a central circular hole containing a diagonal slot. Two rectangular slots are positioned on either side of the center, and a smaller circular hole is located at the bottom.	<p>China as well as Australia and New Zealand</p> <p>R&S ENV216 3560.6550.15</p>
 A square, grey connector with a large circular opening in the center. Inside the circle, there are two vertical rectangular slots, a small circular hole between them, and a semi-circular slot at the bottom. Four screws are visible at the corners of the square frame.	<p>USA as well as Canada, Japan, Korea, Taiwan, Mexico, Central America</p> <p>R&S ENV216 3560.6550.16</p>